

**eMPPT60 series
solar charge controller
User's Manual**



Please read this carefully before you use it

Contents

1. Safety precautions	1
2. eMPPT series controller introduction.....	1
2.1 Features	1
2.2 Functions	1
2.3 MPPT technology introduction.....	4
3. System planning.....	6
3.1 System voltage.....	6
3.2 Solar panels configuration.....	6
3.3 Wiring	7
3.4 Over current protection	8
3.5 Lghtning protection	8
3.6 Grounding	9
3.7 System expansion	9
4. Installation	10
4.1 Product dimension	10
4.2 System wiring diagram.....	11
4.3 Wiring	11
4.4 Installing process.....	11
5. Operation	13
5.1 Button function	13
5.2 LCD interface instruction	14
5.3 Battery parameters viewing.....	16
5.4 View and clearing of PV generating data	16
5.5 View and setting for Absorption charging voltage	16
5.6 View and setting for float charging voltage	16
5.7 View and setting for Language	17
5.8 View and setting Controller communication number.....	17
5.9 Parameters to the factory default value.....	17
6. Troubleshooting	18
6.1 Error code meaning and disposal	18
6.2 Common breakdown phenomena and disposal.....	19
7. Technical Specifications.....	20
8. Quality Assurance	21

1. Safety precautions

- (1) Avoid any inflammable and explosive gases, corrosive gases, dust place when installing the controller.
- (2) Avoid installing the controller directly under sunshine or rain.
- (3) Please do not insert any object into the controller or spill liquid to the controller.
- (4) Do not open or fix the controller by yourself.
- (5) Do not touch the metal part on the controller when the system is working.

2. eMPPT series controller introduction

2.1 Features

eMPPT main topology adopts in Buck conversion circuit, and uses MCU to adjust the solar panels working point intelligently in order to make the solar panels output its maximum power. When the circumstances change, the working point of solar panels deviate from the maximum power point, MCU will adjust the solar panels working point based on MPPT calculation to make the solar panels back to the maximum power point again (refer to 2.3 about MPPT technology introduction). Compared with PWM controller, eMPPT controller can increase the output of solar panels by 5%~30%. The output increasing proportion is affected by the factors such as solar panels property, humidity and light intensity. At the LCD interface, this product adopts in big LCD screen lattice to show the parameters and states, using vivid icon to show individual parameters. The controller uses 4 buttons to realize interfaces shifting and parameter setting. The LCD screen is simple and concise, and the whole machine wall-mount installing (refer to chapter 4.1). Nylon terminal makes the wiring area bigger and wiring loss less.

2.2 Functions

(1) Maximum power point tracking function

Use Buck conversion circuit and MCU technology to track the maximum power point to realize the maximum output of solar panels in different light intensity and temperature, and this can gain more value for customers.

(2) Charging process controlling

The starting charging voltage of battery is different, eMPPT will use the different charging strategies to finalize the charging process. When starting charging voltage of battery is lower than 12.6V(for 12V battery), battery will go through three stages as Bulk, Absorption and Floating charging. When starting charging voltage of battery is higher than 12.6V(for 12V battery), battery will go through two stages as Bulk and Float charging.

Bulk charging: Controller charges the battery by its maximum output current. It is at maximum power point tracking state at this phrase.

Absorption charging: Controller begins to limit the charging current to make the battery voltage fixed at a settled absorption voltage(this voltage has temperature compensation) for 2 hours. This can increase the charging saturation level of battery and prevent battery from leaking gas, and this can increase the longevity of battery.

Float charging: Battery is at saturation state, and the controller charges the battery at a small current to make the battery voltage fixed at the settled float charging voltage(this voltage has temperature compensation).

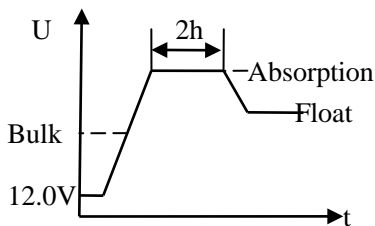

Figure2-1 3 Stages Process

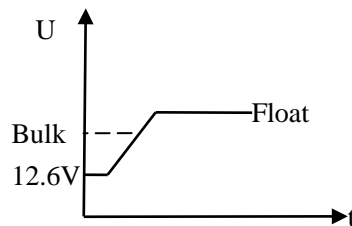

Figure2-2 2 Stages Process

(3) Charging voltage adjustable

Users can adjust the float charging voltage within a certain range. And the default value is 13.8V(for 12V battery).

Users can adjust the absorption charging voltage within a certain scope. And the default value is 14.4V(for 12V battery).

(4) Temperature compensation for charging voltage

eMPPT will compensate the setting Float charging voltage and Absorption charging voltage by $-4\text{mV}/\text{Cell}/\text{°C}$ based on the current battery temperature.

For 12V battery, the compensated voltage $U=(t-25)*6*(-0.004)\text{V}$

For 24V battery, the compensated voltage $U=(t-25)*12*(-0.004)\text{V}$

For 48V battery, the compensated voltage $U=(t-25)*24*(-0.004)\text{V}$

(5) Temperature controlling fan

eMPPT controller will detect the temperature of internal power module. When the module temperature exceeds a certain value, the controller will turn on the fan to take away the heat. It will turn off the fan when the temperature decreases to a certain value.

(6) In night to sleep

When controller detects the voltage of the solar panels is lower than the battery voltage, it will turn off part of the internal circuit to decrease the standby loss. At sleep state, controller will wake up every 4 mins to detect the solar panels voltage and refresh the LCD data, so controller refreshes the data slowly at sleep state. **If users need to check the current data, you can press any button to wake up the controller.** If user haven't press any button within 1 min and the solar panels voltage is still lower than battery voltage, the controller will be back to sleep state again.

(7) Battery reversed connection protection

Connecting the battery to the controller by reversed polarity (under the circumstances of not connecting the solar panels) will not damage the controller. Controller can work normally after connecting right.

(8) Solar panels reversed connection protection

Connecting the solar panels with the controller by reserved connection will not damage the controller. Controller can work normally after connecting right.

(9) Protection for battery reversed discharging

eMPPT controller can prevent battery from discharging to solar panels at night time.

(10) Internal over-heating protection

When controller detects the temperature of internal power module is higher than a certain value, it will stop charging to the battery, and it will restart charging the battery again when the temperature decreases to a certain value.

(11) Over voltage protection for solar panels input

When the input voltage of solar panels exceeds the maximum voltage permitted by the controller, it will enter into protection state automatically and stop charging the battery. When the input voltage recovers to the normal range, the controller will start charging the battery again.

(12) Power limiting for the input of solar panels

When the power of solar panels is too big, eMPPT controller will deviate from the maximum power point to limit the output current to prevent the controller being damaged.

2.3 MPPT technology introduction

Solar panels are nonlinear materials, and the output power is mainly affected by lighting intensity, solar panels temperature and load impedance. When the lighting intensity and solar panels temperature is fixed, the output power of solar panels is only affected by load impedance. Different load impedance will make the solar panels work at different point and put out the different power. The following figure will mark the four working points A, B, C, D, and the working point features as follows:

Working point D: Output voltage is 22.3V, output power is 0W. This point is the open circuit point of solar panels.

Working point C: Output voltage is 0V, output power is 0W. This point is the short circuit working point of solar panels.

Working point A: Output voltage is 13V, output power is 74W. This working

point is the state when using normal controller, and the solar panels voltage is clamped to 13V by battery.

Working point B: Output voltage 17.6V, output power 92W. This point is the state when using MPPT controller. Because of using power conversion technology, the solar panels voltage is not clamped by battery and still works at maximum power point.

Compare working point A & B, it is easy to find using MPPT controller can increase the using efficiency of solar panels. Compared to normal controller, eMPPT controller can generate more power.

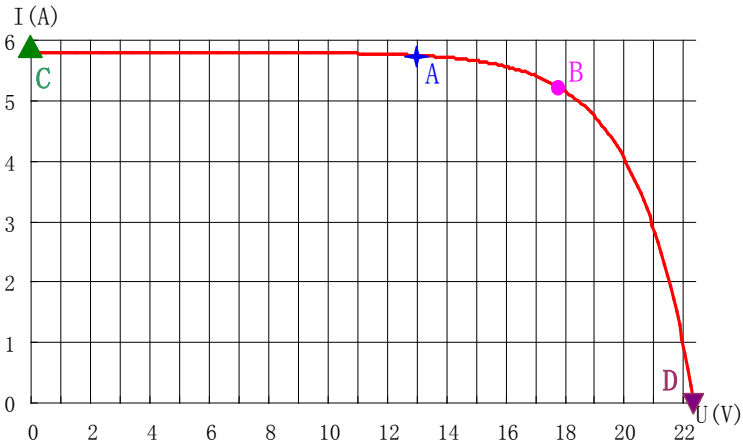

Figure3-1 Voltage-Current Curve

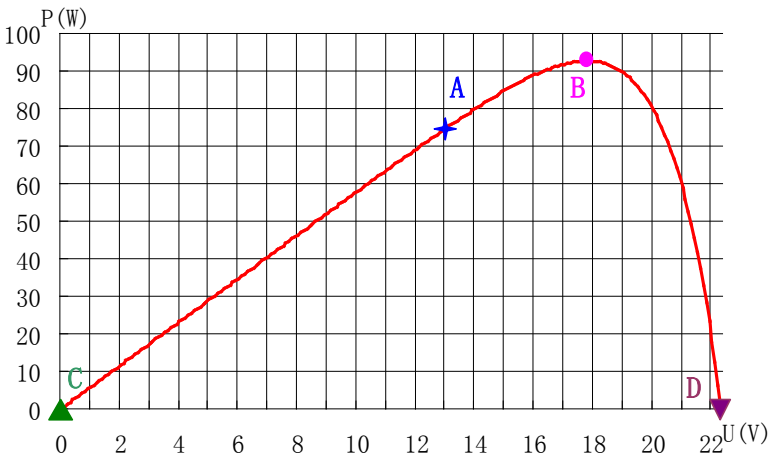

Figure3-2 Voltage-Power Curve

MPPT means maximum power point tracking. It makes the solar panels work at maximum point(ext Point B) by using power conversion technology. eMPPT is the new charge controller researched and developed by our company, and it uses the MCU to track the maximum power point of solar panels intelligently to generate more power from the solar panels.

3. System planning

3.1 System voltage

The common system voltage of solar DC system have 3 types: 12V, 24V and 48V. The higher the system voltage, the more power the system can handle. In reality application, users should consider the load power, and the voltage scope permitted by load, and then confirms which system voltage you should use. The power range for each system voltage is as follows:

System voltage	Suggested power range
12V	<800W
24V	<2000W
48V	<6000W

Table3-1 System voltage and suggested power

3.2 Solar panels configuration

eMPPT series controller can be connected with mono solar panels and also thin film solar panels. When making the system, make sure the open circuit voltage of solar panels array is not higher than the maximum voltage permitted by the controller. Chart one is to introduce the models of mono solar panels and thin film panels and their parameters. Chart 2 is the configuration solution for 12V, 24V and 48V system for solar panels;

Model	Category	Pmax	Voc	Isc	Vpmax	Ipmax
STP140D-12/TEA	Monocry stalline Module	140W	22.4V	8.33A	17.6V	7.95A
MS140GG-02	Thin-film Module	140W	29.0V	7.12A	23.0V	6.52A

STP190S-24/Ad+	Monocrystalline Module	190W	45.2V	5.65A	36.6V	5.2A
NS-F130G5	Thin-film Module	130W	60.4V	3.41A	46.1V	2.82A
The above parameters are for condition of 25°C, AM1.5 spectrum, and 1000W/m ² lighting intensity.						

Table3-2 Solar panels Model and Parameters

Model	For 12V system	For 24V system	For 48V system
STP140D-12/TEA	N in parallel	two in series, N in parallel	four in series, N in parallel
MS140GG-02	N in parallel	two in series, N in parallel	four in series, N in parallel
STP190S-24/Ad+	N in parallel	N in parallel	two in series, N in parallel
NS-F130G5	N in parallel	N in parallel	two in series, N in parallel
"N" means the quantity number required by the current			

Table3-3 Solar panels model and system configuration solution

3.3 Wiring

The maximum input current per channel is 30A. To ensure the cable temperature does not exceed the safety range, the copper cable's area must be $\geq 6\text{mm}^2$. The maximum output current is 60A. To ensure the cable temperature does not exceed the safety range, the copper cable's area must be $\geq 12\text{mm}^2$. In reality application, users can choose the appropriate cables according to the system voltage, permitted cable temperature, cable voltage drop and also cable material. We suggest customer to control the maximum battery voltage loss under 1.5%, and control the maximum voltage loss of solar panels under 2.5%.

The following is the distance between controller and battery, and the suggested copper cables:

Distance	Suggested Cable	Suggested Cable Number	Voltage Loss at 60A (One pair)	Battery Voltage Loss		
				12V	24V	48V
1m	10mm ²	#7 AWG	0.22V	1.8%	0.9%	0.45%
2m	16mm ²	#5 AWG	0.26V	2.2%	1.1%	0.55%
4m	25mm ²	#3 AWG	0.33V	2.7%	1.4%	0.7%

Table3-4 Distance & Cable Voltage Drop

The following is the distance between solar panels and controller, and also the suggested copper cables:

Distance	Suggested Cable	Suggested Cable Number	Voltage Loss at 30A (One pair)	Solar Panels Voltage Loss		
				17V	34V	68V
2m	6mm ²	#9 AWG	0.35V	2.1%	1.03%	0.5%
4m	10mm ²	#7 AWG	0.42V	2.5%	1.25%	0.63%
8m	16mm ²	#5 AWG	0.53V	3.1%	1.55%	0.77%

Table3-5 Distance & Cable Voltage Drop

3.4 Over current protection

The electrical equipment used in power circuit must be equipped with over current and short-circuit protection devices, and there is no exception for eMPPT controller. eMPPT controller adopts in the design of sharing positive pole inside. We suggest users to install over-current breaker or fuse on the negative loop of solar panels input, and also the negative loop of battery output. The capacity of over-current breaker or fuse is 1.25 times of the rated current.

3.5 Lightning protection

It is the same as other electrical devices that eMPPT controller will be damaged by lightning. eMPPT controller has limited surge absorption capacity. We strongly suggest users to install lightning surge absorption devices to increase the reliability of the system.

3.6 Grounding

eMPPT controller has protection grounding terminal. Use 4 mm² yellow and green lines to connect the grounding terminal of the controller to the ground bus of the system. This can decrease the electromagnetic interference in a certain value.

3.7 System expansion

If users want to deploy bigger system, you can expand the system by paralleling several sets of controller. More controllers can share one battery group, but one controller must be connected with one independent solar panels array.

4. Installation

4.1 Product dimension

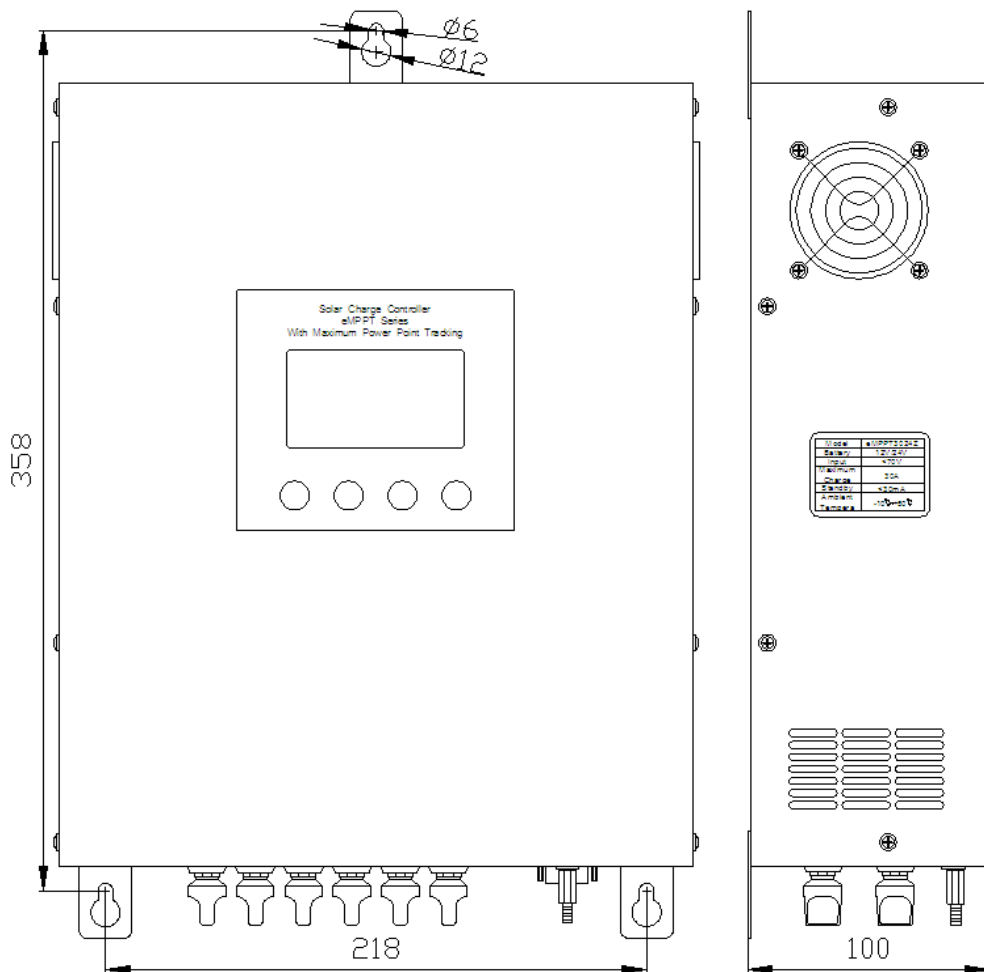

Figure4-1 Product dimension

Mounting hole pitch: 358mm*218mm

Mounting hole diameter: $\Phi 6$ mm

Height*Width*Thickness: 386mm*283mm*100mm

Connecting Terminals: Solar Input M6,Battery Output M8

4.2 System wiring diagram

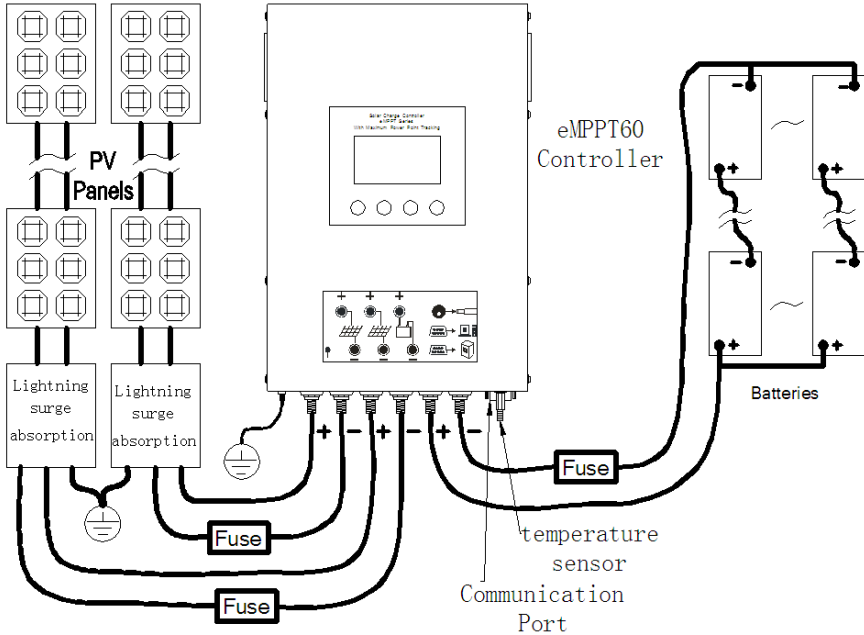

Figure4-2 System wiring diagram

4.3 Wiring

- A、 Choose the appropriate cables requested as chapter 3. Choose the appropriate connections(e.g, Copper cable lugs 6mm²-Φ6, 10mm²-Φ8,see Figure4-3) based on the cross-sectional area. Prepare 3 sets of M6 screw(used to fix the controller on the wall or other vertical things).



Figure4-3 Copper cable lugs

- B、 Prepare cutting pliers and hydraulic clamps (used to press the Copper cable lugs),Copper cable lugs, screwdriver, wrench and multimeter etc.

4.4 Installing process



Note: Please turn off the breakers of battery, solar panels array before installing the controller. Do not touch the positive and

negative pole of solar panels or battery at the same time when installing, otherwise you have the risk of electrical shock..

- A、 Check whether the battery voltage and solar panels array voltage is within the requested range.
- B、 Open the over-current breaker or fuse of the battery and solar panels array.
- C、 Use crimping to press the Copper cable lugs to the cables. Make sure laminated is matchable with the cables, and the Copper cable lugs is matchable with the cables, otherwise it will have the risk of over hot.
- D、 Connect the battery with the battery terminal on controller by cables and fasten the screws; connect the solar panels array with the sola panel terminal on controller by cables and fasten the screws.
- E、 Connect the grounding terminal on the controller to the ground bus of the system.
- F、 Insert the incidental temperature sensor into the pole on the button of the controller;
- G、 If you have choose to install RS232 remote monitoring function, you can connect the computer or remote monitor with the computer communication port on the controller.
- H、 After getting through the over-current breaker or fuse of the battery, please check the LCD screen, at this time the LCD should show the battery voltage info. LCD showing normally means the connecting is right and you can go to the next step. Otherwise refer to chapter 6 for disposal.
- I、 After getting though the over-current breaker or fuse of the solar panels, check LCD screen, and controller will show the current voltage of the solar panels array. If the solar panels array voltage is higher than battery voltage, controller will start maximum power point tracking and the solar panels array voltage begins to drop. If the controller is at sleep state, press any button to wake up the controller.

Note: Suggest you stall the controller on the vertical surface and make sure there are space about 10cm around the controller to make better cooling. Suggest you save 20cm on the bottom of the controller to make the connection of cables convenient.



5. Operation

5.1 Button function

Button	Operation	Function
+	Press Shortly	Nonparametric setting state, short press forward flip menu. In the parameter setting state, short press this key can be setting increases.
	Press Long	In the parameter setting state, long press can automatically increase the set value.
-	Press Shortly	Nonparametric setting state, short press reverse flip menu. In the parameter setting state, short press this key can be reduced setting.
	Press Long	In the parameter setting state, long press can automatically reduce the set value.
OK	Press Shortly	In the parameter setting state, it is used to switch to the different setting item of the same page. At the confirmation page, it used to confirm the current operation. Press this button shortly when there is breakdown, and you can enter into trouble shooting page.
	Press Long	Parameter Settings page, long press to enter the parameter setting state, In the parameter setting state, long press to save the current parameters and exit the set state.
ESC	Press Shortly	In the parameter setting state, it is used to cancel the current parameter revising; At the confirmation page, it used to cancel the current operation. Nonparametric setting state, it is used to switch to the main page quickly.
	Press Long	no meaning

5.2 LCD interface instruction

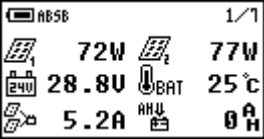
The showing interfaces consist of 5 interfaces. Each interface has 4 lines. The first line is the state indication line, and it indicates the working condition of the whole system or the breakdown information. The icon of the upper right corner of each interface is indication of the current interface. The first number means the current interface, and the second one means the whole interface. Please refer to the following form to check the functions of each interface (take 24V system as an example):

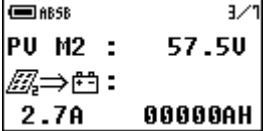
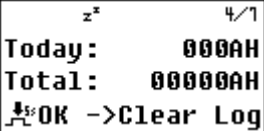
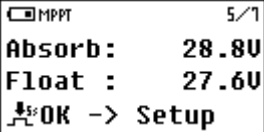
Interface icon	Interface instruction
	It shows the parameters of the system in general: charging mode, breakdown code, battery voltage, battery temperature, battery charging current(controller will show this interface after opening the system).
	It shows the total accumulative charging AH of channel 1.
	It shows the total accumulative charging AH of channel 2
	It shows the accumulative charging AH today, the total accumulative charging AH. Operate at this interface to clear the accumulative charging AH.
	The setting interface for elevating charging voltage and float charging voltage.

<p>z² 6/1 Language:English Comm NO.: 01 OK -> Setup</p>	<p>System language choose and setting page for remote control's number</p>
<p>ABS E102 7/1 Model:eMPPT6024Z Firmware: V1.02 OK -> RST DFLT</p>	<p>Controller's model, Firmware version information and The factory default recovery</p>
<p>FAULT CODE: E102 HeatSink hot! Stop charging until HSK cool</p>	<p>Breakdown code indication and disposal indication. This interface does not exist if no breakdown. The interface comes after the main interface if the system has breakdown.</p>

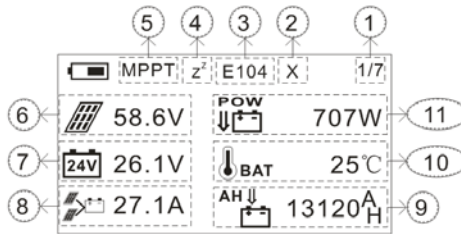

Figure5-1 LCD main page

- (1) It means there are 7 pages, and now it is the first interface.
- (2) It means controller has internal breakdown;
- (3) It means the controller detects breakdown, and it will prompt to the users.
 And please refer the disposal to chapter 6.
- (4) It means the controller is in sleep state if this icon appears.
- (5) Means the current charging stages:
 MPPT means it is in Bulk charging stage;
 ABSB means it is in Absorption charging stage;
 FLOT means it is in Float charging stage.
 CLTD means the solar panels power is too big, and the controller starts to limit the current.
- (6) It means the current solar panels voltage;

- (7) It means the current battery array is 24V and the battery voltage is 26.1V.
- (8) It means the total charging current for battery is 27.1A;
- (9) It means the accumulative charging AH is 13120AH;
- (10) It means the environmental temperature of controller is 25℃ ;
- (11) It means the charging power from controller to battery is 707W.

5.3 Battery parameters viewing

Battery parameters will be showed at the first page of the main page. It includes the parameters as battery voltage, charging current, charging state, environmental temperature and accumulative charging AH.

5.4 View and clearing of PV generating data

PV generating data is in the second page It includes the accumulative generating AH of the controller and the generating AH for yesterday. Press OK button for 5 seconds and it enters into the confirming page of clearing the accumulative generating AH. Press this OK button for 5 seconds again, you will clear this data. Press ESC for short can cancel the setting. No operation in 20s, it will exit this page automatically.

5.5 View and setting for Absorption charging voltage

Absorption charging voltage data is in the third page. Press OK for 5 seconds, and it enters into parameter setting state. Wait until the pending setting parameter flicking, press +, - shortly to adjust the parameter, and the adjusting step is 0.1V. Press OK for 5 seconds can save the revised the parameter. Press ESC shortly to exit the page without saving the revised data. Press OK and it can switch to another setting parameter. No operation without 20s, the controller will exit the adjusting state.

5.6 View and setting for float charging voltage

Float charging voltage data is in the third page. Press OK for 5 seconds, and it enters into parameter setting state. Wait until the pending setting parameter flicking, press+, - shortly to adjust the parameter, and the

adjusting step is 0.1V. Press OK for 5 seconds can save the revised the parameter. Press ESC shortly to exit the page without saving the revised data. Press OK and it can switch to another setting parameter. No operation without 20s, the controller will exit the adjusting state.

5.7 View and setting for Language

Language selection page is the forth page. Press OK for 5 seconds, and it enters into language selection page. Press +,- to choose your target language. Press OK for 5 seconds to save the revised data. Press ESC shortly to exit the page without saving the revised data. No operation in 20s, the controller will exit the page.

5.8 View and setting Controller communication number

The setting of the controller communications number is at the forth page. At this page, press OK for 5 seconds to enter into language setting state; press OK shortly to switch into controller tcommunication number setting state; use +,- to adjust the communication number; press OK for 5 seconds and the modified data can be saved. Press ESC shortly to exit the page without saving the modified data. The controller will exit the parameter adjusting state automatically if no operation on the controller in 20s.

5.9 Parameters to the factory default value

Use +,- to switch the page to the fifth , Press OK for 5 seconds to enter into the page to recover the default. Press OK again for 5 seconds to confirm it. Press ESC shortly to exit the page. No operation within 20s, the controller will exit the page automatically.

6. Troubleshooting

6.1 Error code meaning and disposal

Error Code	Code meaning and Cause of breakdown	Disposal
EX01	Solar panels input over voltage protection: the voltage of solar panels array is over rated value, and the controller stop charging	Check whether the solar panels model is right, check whether too much solar panels in series
EX02	Internal over heating protection The temperature of internal power model is too high, controller stop charging.	Check whether cooling holes blocked, Check whether the Environment temperature too high
E003	Battery low voltage alarm battery can not get supplementary power for long time	Check whether the solar panels or cables damaged, Check whether the load power too big
EX04	Breakdown of internal power module	Send back to distributor
E005	Battery over voltage alarm, Other charging devices output voltage too high	Disconnect other charging devices to battery
X=1,means channel 1 was error! X=2,means channel 2 was error!		

6.2 Common breakdown phenomena and disposal

Breakdown Phenomena	Possible Breakdown Reasons	Disposal
No showing on LCD	Battery polarity connection reverse	Check whether the connecting polarity of the battery is right
Showing voltage on LCD ,does not coincide with the actual voltage	Controller in hibernation state, slow data updating	Press any button to wake up the controller
Charging voltage fluctuate fast	Controller and inverter share the cables	Separate the cables for the controller and inverter
Environmental temperature shows"? "	Did not connect the temperature sensor	Insert the temperature sensor into the hole is the button of the controller
Controller in direct charging state	The maximum power point of solar panels too low	Do not affect using. Connect more solar panels in series to improve the working point of solar panles

7. Technical Specifications

MODEL		eMPPT3024Z	eMPPT3048
Input	Input Voltage Range of Solar Panels	≤70V	≤130V
	Maximum Power Point Tracking Range	12V~70V (12V) 24V~70V (24V)	48V~130V
	Input Route	2 channel	2 channel
Output	Nominal System Voltage	12V/24V Auto	48V
	Maximum Charging Current	60A	60A
	Self Consumption	≤50mA	≤50mA
	Charging Stages	Bulk、Absorption、Float	
	Float Charging Voltage	13.8V(12.8V~14.2V) ×1/×2/×4	
	Absorption Charging Voltage	14.4V(13.6V~15.2V) ×1/×2/×4	
	Temperature Compensation	-4mV/Cell/°C	
Others	Maximum Efficiency	97%	
	HMI	LCD and Button	
	Cooling Mode	Temperature-controlled Active Cooling	
	Connecting Way	M6 and M8 Terminals	
	Ambient Temperature Range	-10°C~+50°C	
	Humidity	0~90%, No condensation	
	Dimensions	380mm*283mm*100mm	
	Product Weight	5.7Kg	5.9Kg
	Storage Temperature	-30°C~+80°C	
	Optional Function	Remote Monitoring (RS485 or RS232, DB9 Port)	

8. Quality Assurance

8.1 Quality assurance should be carried out according to the following rules:

- The product is guaranteed of replacement, returning and repairing within 7 days after Sale.
- The product is guaranteed of replacement and repairing within 1 month after sale.
- The product is guaranteed of repairing within 12 months after sale.

8.2 If it is not possible to identify the using date of the controller, we would refer to the ex-work date, and prescribe 18 months as the warranty period. We need to charge beyond the warranty period. The controller can be repaired for life no matter when and where you use it.

8.3 If the controller is damaged by the following causes, we need to charge even if it is in the guarantee period:

- Do not operate according to the user's manual.
- Use the controller under the condition which is beyond the using standard and technical requirements.
- Repair by yourself or reform by yourself.
- The inappropriate environmental condition which can cause the breakdown and aging of the apparatus.
- Improper carrying or storage.
- Regarding to the service of replacement, returning and repairing, you need to retreat the product to our company, and we decide whether to replace or repair after we make clear who should be responsible.

8.4 We will not note if there is any change of this product.